

Technical User Manual







JDIR-LCPA-DR37

*Multi-Band Industrial Digital Repeater
GUI with Remote Access*



Safety.....	2
1. Preface.....	3
2. Introduction / Features & Functions.....	5
3. DAS Installation.....	7
3.1 Installation Procedure.....	8
3.2 Installation Procedure – Antenna Mounting.....	10
3.3 Installation Procedure – Repeater Mounting.....	11
4. Installing the Graphic User Interface (GUI).....	13
4.3 Accessing the GUI.....	15
5. Using the GUI.....	18
6. Testing.....	22
7. Troubleshooting.....	23
8. FCC Statement / Warning.....	24
9. Specifications.....	25
10. Abbreviations.....	27

User Warnings – MUST READ!

-  1. This repeater must ONLY be used for the purpose it was intended for. Making any alterations to the design layout without first consulting with a trained technician can result in interference to the operator's network and liability by the end user.
-  2. Please read this entire manual carefully before using this product!
-  3. Only the power supply that came with the repeater should be used at all times. It is highly recommended that the repeater is grounded and lightning protection used.
-  4. Do not attempt to open any sealed part of the repeater. This will void the warranty and can cause an electric shock. Electrostatic can also cause damage to the internal components.
-  5. Please keep away from any heating-equipment, because the repeater will dissipate heat when working. Do not cover the repeater with anything that influences heat-dissipation.
-  6. Do not use an unauthorized antennas, cables and / or coupling devices not conforming with the ERP/EIRP and/or indoor-only use restrictions.

WARNING! This is NOT a CONSUMER device.

It is designed for installation by FCC LICENSEES and QUALIFIED INSTALLERS. You MUST have an FCC LICENSE or express consent of an FCC Licensee to operate this device. Unauthorized use may result in significant forfeiture penalties, including penalties in excess of \$100,000 for each continuing violation.

For North American Market.

1. Preface

Personal mobile communication is now part of daily life and persons have come to expect a robust network that meets their increased demand for an always-on network that provides seamless coverage and unlimited bandwidth at high speeds. Cellular repeaters are an integral part of achieving this goal.

A cellular tower in a non-metro environment typically supports a large number of users but is affected by a relatively small coverage footprint. Therefore, the average number of users who can access it is limited and a large amount of channel resources go unused. The best way of solving this problem is to use repeaters to extend the BTS coverage to fully utilize the telecommunication resources. Hence cellular repeaters are no longer considered as peripheral devices to cover blind areas in the network but as part of the core network itself. Extending coverage and maximizing the available network resources and revenue growth for the operator.

The complete coverage approach is not only a prerequisite for a high quality mobile cellular network, but also a factor that attracts users. From this point of view, a network operator should first consider providing a radio network architecture with complete coverage in mind. This includes seamless coverage in urban areas, heavy traffic areas, office buildings, supermarkets, and hotels as the first step. Cellular repeaters successfully aid in accomplishing this.

With this in mind, JDTECK has focused on successfully developing advanced repeaters that are applicable to any mobile network and indoor distributed antenna system (DAS). Repeaters are available to support any technology or frequency in use today.

Because a large amount of BTS or Node B devices are deployed in densely populated urban areas, there is usually no large blind area, therefore repeaters are predominantly used to provide coverage inside buildings, sub-ground locations or rural outdoor areas. Typically, radio frequency (RF) repeaters are used when optical fibers are not available in buildings or when using a fiber solution is not cost effective.

Since the number of repeaters on a cellular network usually increases with the number of buildings to be covered in a specific sector, multiple repeaters may end up feeding from one BTS or Node B. In view of this, the design of the DAS is extremely important to maintain an acceptable noise floor and thus achieve seamless integration to the macro network especially in densely populated areas.

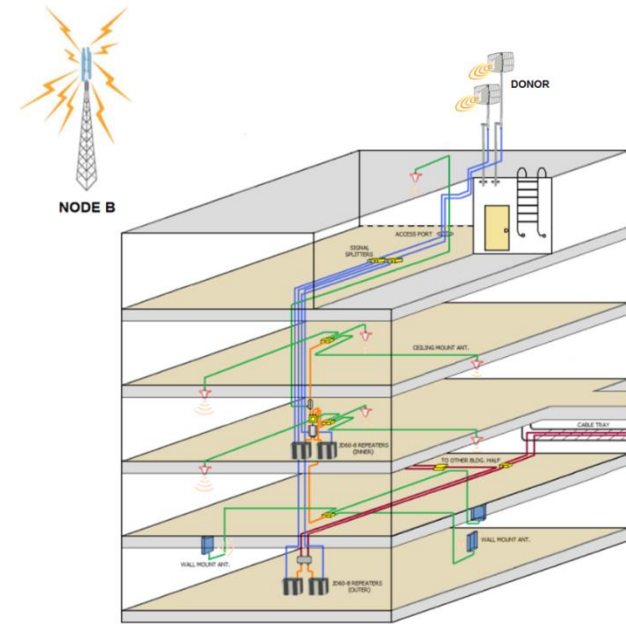

Figure 1 shows an **indoor** application of repeaters. (I-DAS)

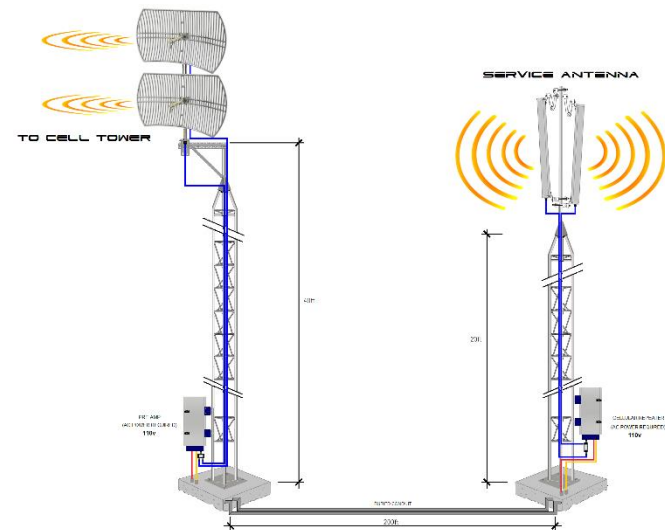

Figure 2 shows an **outdoor** application of repeaters. (O-DAS)

2. Introduction

JDTECK has engineered an advanced industrial grade digital repeater for Distributed Antenna Systems with the ability to function in either a wideband or narrow band mode. This core component helps create the perfect solution for providing a wireless improvement in the cellular reception of a large office or apartment building, hotel, underground parking garage or remote outdoor location.

It is designed to improve the call quality of an area by receiving, amplifying, filtering and re-transmitting the signals from the macro base station into a specified area via a distributed antenna system (DAS).

This highly advanced digital unit uses a Graphic User Interface (GUI) to access and select the desired active bands or channels, set any alarm trigger points as well as configure and control the parameters of the repeater which by extension controls the entire DAS it's mated to either locally via USB or remotely via Ethernet.

To maintain safe and specific output power levels, the GUI of this industrial grade digital repeater has a wide range of configurable settings which allows the repeater to function strictly within the parameters set by the end user. These features include built-in **Signal Oscillation Detection** circuits with color changing indicators for the respective bands (Green, Orange or Red depending on the intensity), **Automatic Gain Control (AGC)** which will dynamically reduce the gain of the repeater up to 10dB if oscillation or a high input signal is detected. **Manual Gain Control (MGC)** to bring the repeater into a set safe operating limit as well as a **Network Safe / Auto MUTE** feature that immediately shuts-down the RF transmission circuit of any frequency band that exceeds its set output power limits. There is also an **Uplink Sleep** mode which shuts down the UL band of the repeater if no activity is detected on the DAS after a set period of time. All features that rigorously protect the macro cellular network from harmful interference.

There is master alarm indicator on the header of the GUI as well as an external LED on the enclosure of the repeater which changes color from green to red to alert the user if any alarm is detected. The user also has the option to have the repeater send automatic email or SMS notifications to specific addresses or numbers alerting the recipients to access the repeater to make any needed adjustments.

This multiband industrial grade digital repeater from JDTECK is truly a very user friendly, flexible and highly intuitive device that customers and system integrators alike will enjoy using for many years to come.

2. Features & Functions

- ✓ Intuitive GUI with local USB access and remote access via Ethernet.
- ✓ Stable Performance and Technical Parameters.
- ✓ Wide range of preset and customized bandwidth options.
- ✓ IP55 enclosure with large cooling fins for heat dissipation.
- ✓ External LED indicators that display environmental conditions.
- ✓ Supports all protocols. (GSM, WCDMA, UMTS & LTE)
- ✓ ALC function. (Automatic Limit Control – User chooses set limit)
- ✓ AGC function. (Automatic Gain Control with option to disable)
- ✓ MGC function. (Manual Gain Control – Up to 40dB)
- ✓ MUTE auto shutdown function. (Keeps macro network safe)
- ✓ Uplink Sleep Mode. Shuts down UL if no activity detected after 5 min.

Graphic User Interface – Dashboard View

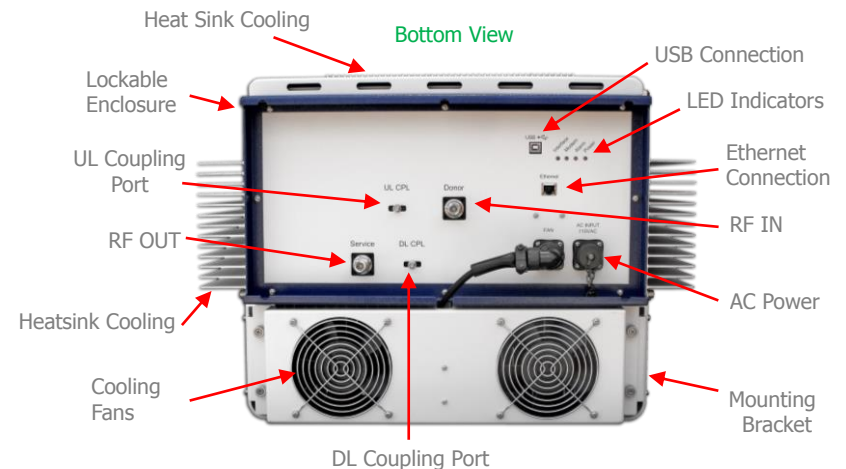

3. DAS Installation

1. The repeater's main function is to improve weak RF signals to an area.
2. Selecting the appropriate accessories that are compatible with this digital frequency repeater is very important for optimal system performance. Since this is a multiband repeater, it's important that all the peripheral components used in the DAS supports all the frequencies that are going to be needed and that all the components are Low PIM rated.
3. The signal strength and quality at the donor antenna directly affects the efficiency of the indoor coverage. Therefore, it is very important to choose the location of the outdoor antenna carefully. With this in mind, it is recommended that the donor antenna be installed in clear line of sight (LOS) to the serving sector/s.
4. The repeater is a two-way (full duplex) digital signal amplifier so, there needs to be proper isolation between the outdoor antenna and indoor antennas in order to avoid signal oscillation of the repeater. (Feedback) There needs to be more than 15dB of isolation above the repeaters gain. For example, if the repeater gain is 80dB, then you need 95dB of isolation between outdoor antenna and indoor antenna.
5. The repeater gain is adjustable for both the uplink / downlink individually. Depending on the environment, the end-user may need to adjust the repeater gain to achieve optimum performance and desired coverage.
6. The repeater is designed to amplify the input signal, filter it and retransmit it to the desired area via service antennas. In order to reach the best performance, the outdoor signal should be better than -80dBm with an $E_c/I_0 < 6$ and an RSRQ of < 12 dB. If the outdoor signal is very weak, then a pre-amplifier may be used.
7. Calculating the Link budget before setting the repeater gain.

Link budget calculation:

Outdoor signal strength – Loss of accessories (cable, connectors, splitters, Directional Couplers, Path Loss) + Antenna gain (outdoor antenna, indoor antenna) + Repeater gain = Indoor signal strength.

8. For all cellular applications, you should only use 50 Ohm rated coax. Besides affecting voice quality, using any other impedance of coax will affect the throughput performance of services over LTE as well as shorten the life of the repeater.

3.1 Installation Procedure

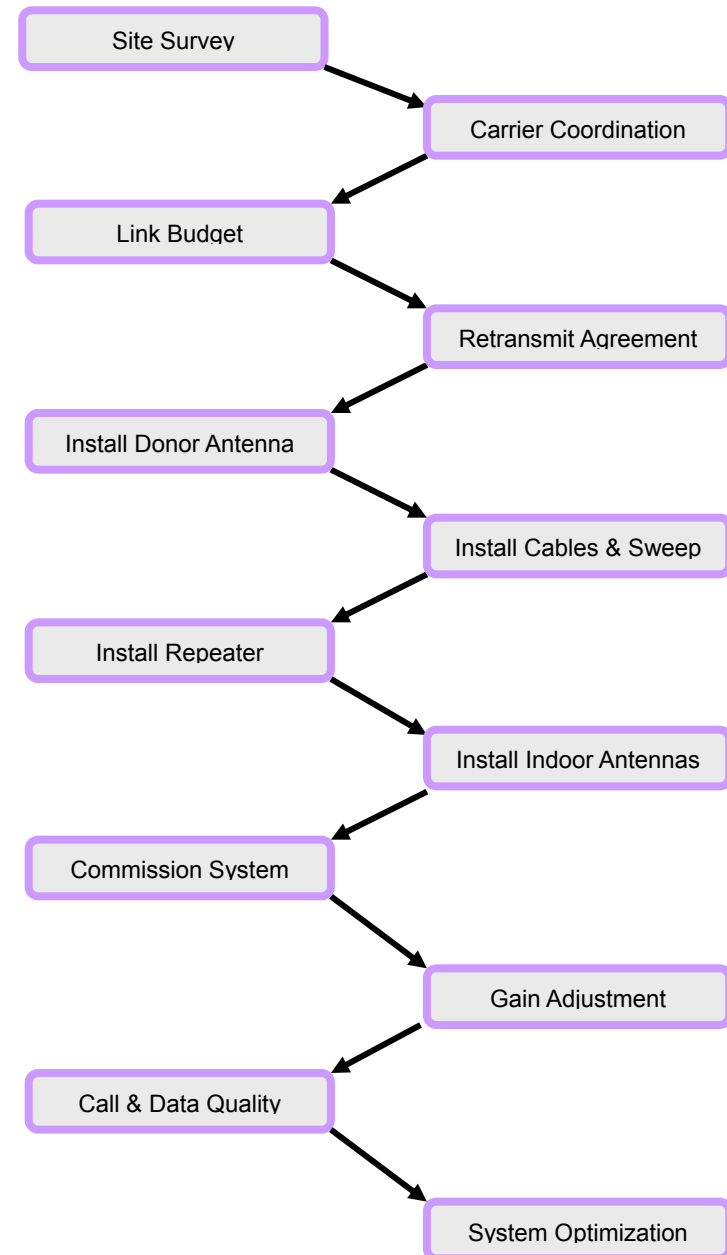

3.1 Installation Procedure – Cont.

- Check the contents supplied against your packing list & DAS design.
- Identify a suitable location where the donor antenna will be installed on the roof or at an elevated location free of any other antennas or immediate obstructions. Confirm this location has the best input signal for the carriers you would like to support using test equipment. Ensure the location is properly isolated from any of the indoor service antennas so as to avoid signal oscillation.
- Identify the location for the head-end equipment and that suitable AC power and a lightning ground is available. Using the DAS design provided, walk the entire space to confirm all the components and cable access paths of the DAS can be installed without any omissions.
- Install the donor antennas at the suitable location identified and start the cabling process. **DO NOT COIL UP** any excess coax or create any service loops in your system. These are detrimental to cellular performance. Be sure to weather proof all your external connections and fire stop all ports of entry.
- Carefully follow your DAS diagram to ensure all the components are installed according to the design. Any alterations made to the system layout without informing the DAS design engineer could result in poor system performance or interference to the macro.
- It's **EXTREMELY IMPORTANT** that all your cable terminations be done properly and line sweeps completed using the appropriate test equipment. (*Frequency Return Loss*) Directional couplers **MUST** be installed in the right direction and with the correct values as outlined in the DAS design. **DOUBLE-CHECK ALL YOUR WORK!** The extra time you invest to do so will pay-off with a smooth and successful commissioning process.
- If multiple repeaters are deployed, start by commissioning one repeater at a time. It's best to start with the frequencies that support voice communication, then move on to data (4G, 5G, LTE). Upon commissioning, quickly work towards getting the LEDs on the repeater to a green status by adding attenuation as needed. First on the DL, then on the UL.
- If signal oscillation or a strong input signal is between 1–4dB over the acceptable range then the field alarm for the respective band will turn orange (See manual gain adjustment). If the signal oscillation is between 10-15dB then the field alarm for the respective band will turn red and the circuit will then go into MUTE / Shutdown (Grey). This is as a result of not having enough isolation between the donor and service antennas or the input signal at the donor antenna is too strong.

3.2 Installation Procedure – Antenna Mounting.

- In this case, attenuate the DL gain on the repeater and then match the UL gain to the same gain value. After each gain adjustment is made, click the power cycle tab on the GUI. This will take the repeater out the MUTE / Shutdown state. (See attenuation settings for adjustments)



"The installation height of the antenna for AWS band (1700/2100 MHz) operations is limited to 10 meters above ground for compliance with 47 CFR 27.50

- Do not install the donor antenna near high voltage power lines.
- Please take the necessary safety measures when working on heights.
- Do not mount near or in the path of other antennas or satellite dishes.

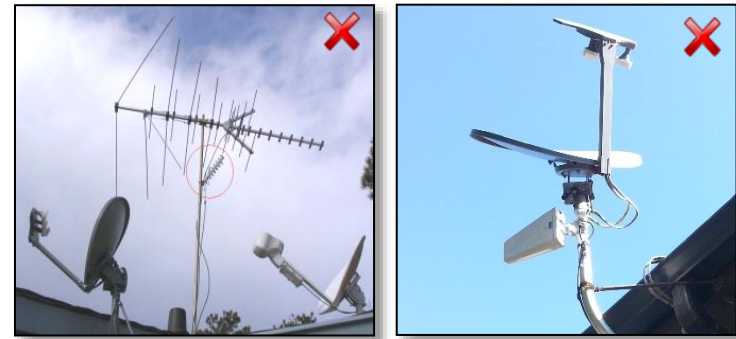

It is recommended that you mount your donor antenna in a spot that is free of any immediate obstructions. Making use of a dedicated mast or mounting bracket is recommended for optimum antenna performance.



3.3 Installation Procedure – Repeater Mounting.

The JDTECK industrial digital repeater is designed to be mounted on a wall. Carefully remove the repeater from the box and place it upright on a protected surface like cardboard or carpet. Then remove the mounting bracket from repeater and securely bolt bracket to the wall. Be sure to use a plumb level so the bracket is perfectly straight when completed.

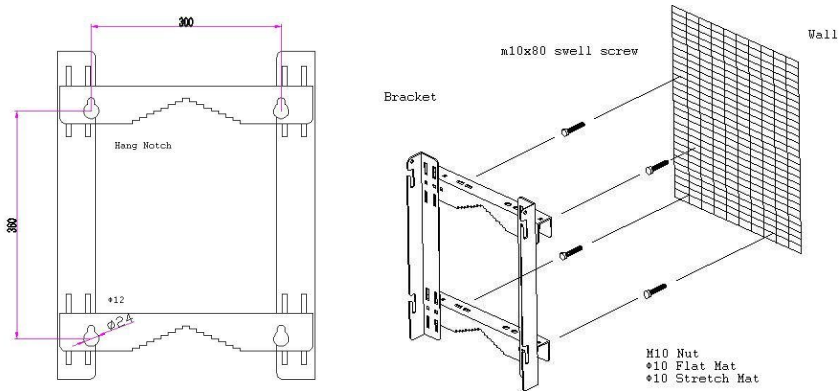

Install conduit from above ceiling to communications board, route coax through conduit, then slide repeater onto bracket.



3.3 Installation Procedure – Repeater Mounting Cont.



Always dress in and label cables properly so communications board looks neat and professional.



4. Installing the Graphic User Interface. (GUI)

A USB thumb drive is shipped with each repeater which has the GUI program stored on it. Install the GUI program onto a Laptop PC that will be used to initially access and configure the repeater. Please note that the GUI can only be initially accessed via a USB cable connection. You will also need to have an internet connection to download Java.

Click on file name **JDTECK_GUI.exe** to install program. Please allow a few seconds for process to start.

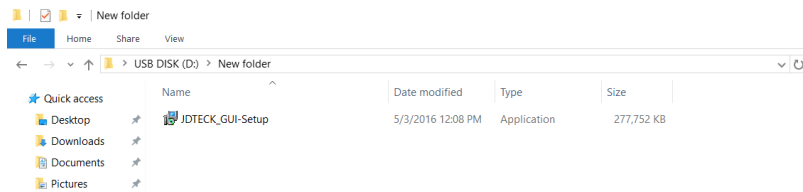

The following error will most likely pop up. Go ahead and click yes.

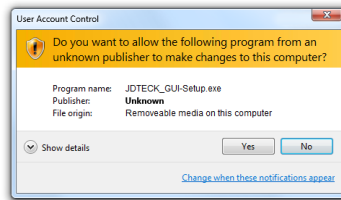

You will then be prompted to start the install sequence. Click next. Be sure to leave the check box selected to create a desktop shortcut.

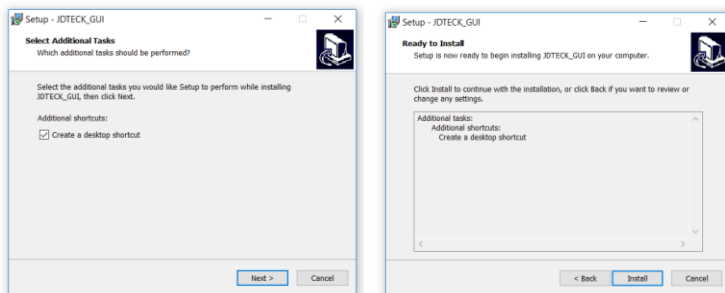

4.1 Installing the GUI. (Con't)

Java Development Kit is required to run the GUI. If none is detected, you will be prompted to install it. Click OK on both windows.

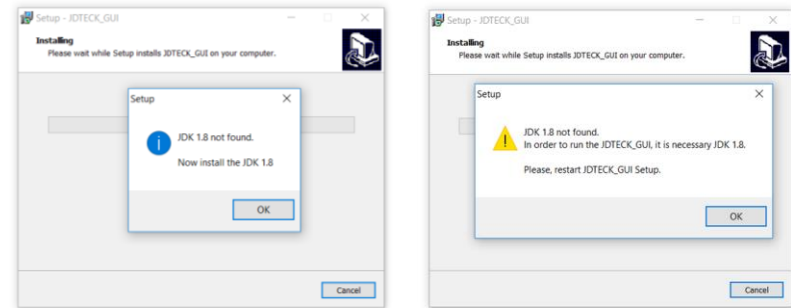

The install sequence will begin and complete, however you will again be prompted to install Java Development Kit (JDK). The second time, a link to Oracle's website will launch.

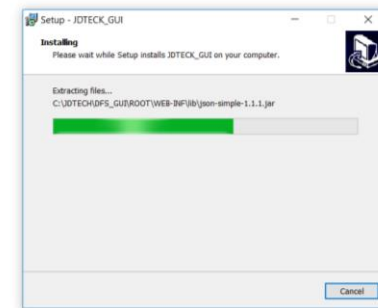

On the Oracle site, **click** on the following link.

Java SE Downloads



Java Platform (JDK) 8u91 / 8u92

4.2 Installing the GUI. (Con't)

You will then be show several options to choose from. Scroll down to Java SE Development Kit 8u92 and select **“Accept License Agreement”**. Then choose the operating system compatible with your PC.

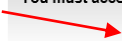
Click Here 

Java SE Development Kit 8u92
You must accept the [Oracle Binary Code License Agreement for Java SE](#) to download this software.

Accept License Agreement Decline License Agreement

Product / File Description	File Size	Download
Linux x86	160.26 MB	jdk-8u92-linux-i586.rpm
Linux x86	174.94 MB	jdk-8u92-linux-i586.tar.gz
Linux x64	158.27 MB	jdk-8u92-linux-x64.rpm
Linux x64	172.99 MB	jdk-8u92-linux-x64.tar.gz
Mac OS X	227.32 MB	jdk-8u92-macosx-x64.dmg
Solaris SPARC 64-bit (SVR4 package)	139.47 MB	jdk-8u92-solaris-sparcv9.tar.Z
Solaris SPARC 64-bit	98.93 MB	jdk-8u92-solaris-sparcv9.tar.gz
Solaris x64 (SVR4 package)	140.35 MB	jdk-8u92-solaris-x64.tar.Z
Solaris x64	96.76 MB	jdk-8u92-solaris-x64.tar.gz
Windows x86	188.43 MB	jdk-8u92-windows-i586.exe
Windows x64	193.66 MB	jdk-8u92-windows-x64.exe

After selecting the appropriate operating system, click **next**.



After you have installed Java, you will be prompted to restart your PC. Please do.



4.3 Accessing the GUI.

After you have installed the GUI program and restarted the PC, the user will **first** switch the repeater ON and wait for the boot sequence to complete. This is indicated by the LED's at the bottom of the repeater. The LED's turn from RED to GREEN. This will take about 1-2 min.

Main Power Switch

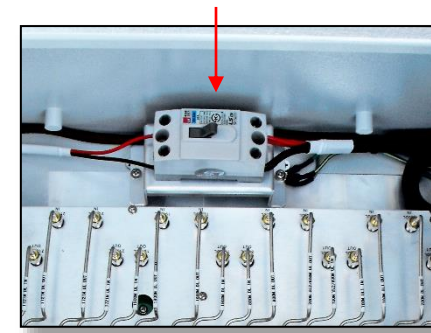

After the LED's turn green, connect the supplied USB cable to the repeater and your PC.

Connect USB

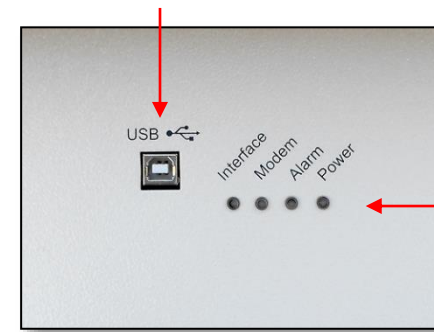

Next click on the JDTECK GUI Icon.



4.4 Accessing the GUI. (Con't)



If the GUI screen comes up blank, it's because Java did not install correctly. It would be easiest to just reinstall the program again from the thumb drive where you would again be prompted to download the correct Java Kit and restart the install sequence.

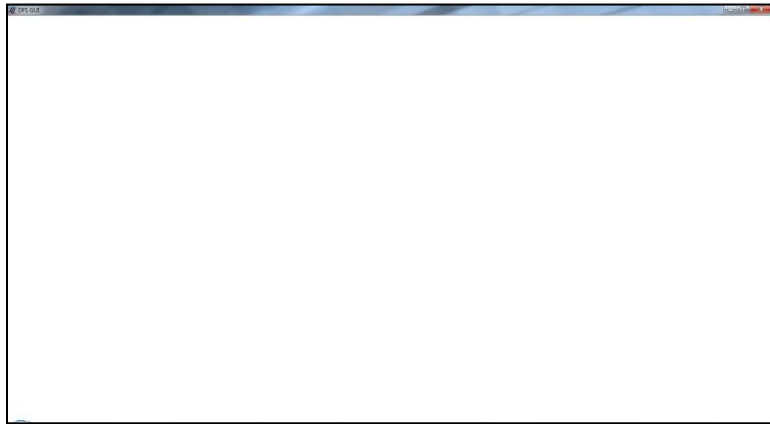

Upon a successful installation, the following screen will appear. Here you will select the connection type (**USB**), the device type (**DR-37**) and the **COM Port**. This is typically COM Port 4, however you can double check by going to **Device Manager** on your PC to see which port is active.



4.5 Accessing the GUI. (Con't)

When the correct COM Port has been selected, the following screen will appear. Click **OK** to proceed.



The first screen to appear is the Band Select Page. On this page, the user will select which bands they want to support. You also have the option to assign the repeater a name or ID on this page at the header.

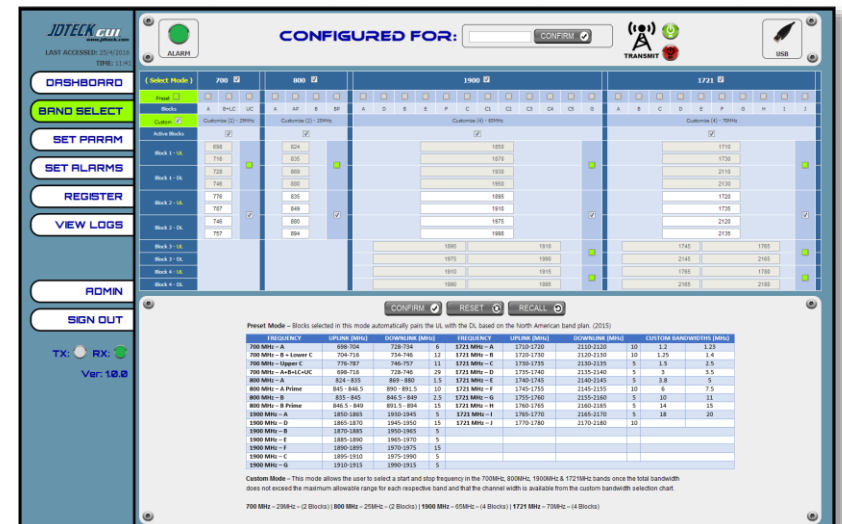

5. Using the GUI. (BAND SELECT)

The GUI is inherently intuitive and very user friendly. The user simply selects the bands they would like to support and click confirm. They can choose from either the preset band selections or customize a selection as needed. In the custom selection mode, the user can select all the bands at the very top which will activate all the blocks within the bands. This will allow the repeater to run in wideband mode. (All Channels in All Bands). Ideal for enterprise deployments where the user would like to support all carriers.

The user also has the option to select multiple non-contiguous blocks or channels they would like to support. (2) for 700 MHz, (2) for 800 MHz, (4) for 1900 MHz and (4) for AWS. These are typically used in carrier applications. No matter which options are selected, the user must remember to click **CONFIRM** for the GUI to register the selection. Please note that clicking **CONFIRM** will NOT send the repeater into transmission mode, it will only log the data inputted or selected. This allows the user to continue with setting up the parameters and alarms for the repeater even before going live with transmission.

There are several other neat features you will notice on the header as well as internal of each page. These include:

- A **MASTER ALARM** on the top left which is synced with the alarm LED on the outside / bottom of the repeater enclosure so even if the user is not logged into the GUI, they can observe if an alarm is present or not.
- A dynamic **ICON** on the top right of the GUI that indicates how the user is interfaced with the GUI. Either via USB or Ethernet.
- A **CONFIRM** button that registers the selections on each page.
- A **RESET** button which resets all the settings on that page to factory default.
- A **RECALL** button which will repopulate the fields with the last saved selection.
- Bold, easy to view, color changing navigation tabs on the left so at any time the user knows which page they are on or where to navigate to next.
- A dynamic **TX & RX** status indicator to show communication activity between the GUI and the repeater.

5.1 Using the GUI. (SET PARAMETERS)

The **SET PARAMETERS** page allows the user to set the high-limit (*not to exceed*) points of the repeater on the bands that were activated on the **BAND SELECT** page. Only the active band fields are editable. The user can individually adjust the **UL** and **DL** attenuation values which directly influences the Output Power for each respective band. This page also displays the status color of the respective band so the user knows which band to adjust. Once on this page, the response to the adjustment is not dynamic, so the user will need to click on the dashboard to see the effect.

Also working fixed within the program is an **Automatic Gain Control** feature (**AGC**) which dynamically adds attenuation to the respective band to maintain the output power limit set by the user for **UL** and **DL**.



Because the repeater has dynamic AGC, the status fields will only change color from Green to Orange or Red when the AGC threshold has been exceeded. An infringement that is between 1-5dB over the AGC range will change color from Green to Orange. If between 6dB and 10dB, it will change to Red. If above 10dB, the respective circuit will go into active **MUTE / Shutdown**. To get the unit out of MUTE, first add more DL attenuation to the respective circuit, power cycle the repeater's transmit circuit and then click on the DASHBOARD to see the change. The fields on this page come preset from the factory with the following values:

- ✓ **20dB** of attenuation on the **UL** and **DL**.
- ✓ **20-23dBm** Output Power Limit for the **UL**.
- ✓ **31dBm** Output Power Limit for the **DL**.

5.2 Using the GUI. (SET PARAMETERS)

On this page, the user also has the option to select up to any 5 bands they would like the **QUICK VIEW DIALS** to monitor which dynamically display the **DL** output power over on the **DASHBOARD** page.

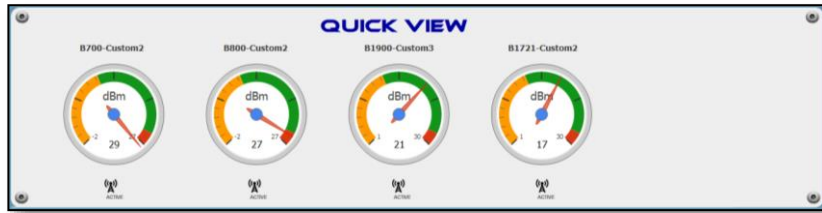

4. Using the GUI. (SET ALARMS)

On the **SET ALARMS** page the user can set the trigger points for when an alarm will activate and display RED or optionally send an automated notification out to as many as 4 users simultaneously. The parameters monitored on this page include **Low RSSI**, **Low Output Power**, **MUTE** activation and **Signal Oscillation**. The user can define what they consider to be a low threshold point when an alarm should be triggered and a notification sent for the RSSI and Output Power limit. They also have the option to select if they want a **MUTE** or **Oscillation** notification sent out as well. If the email and SMS fields are not populated, alarms will just be displayed and logged.

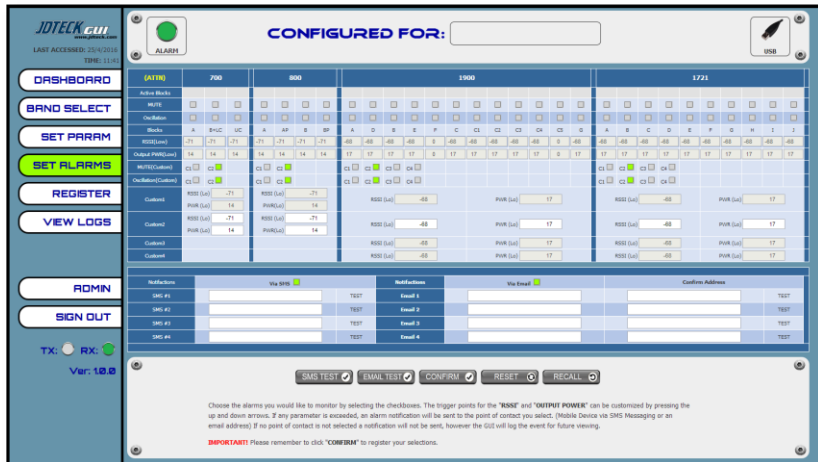

5.3 Using the GUI. (DASHBOARD)

The **DASHBOARD** page provides an overview of how the repeater is functioning. The view of this page dynamically changes depending on if the repeater is operating in preset or custom mode.



The RSSI, AGC, MGC, Output Power, UL Overdrive, UL Sleep, MUTE, Alarms, Operating Temps and Quick View Dials are all dynamically displayed in real time on this page. The user gets to see when the output power exceeds the set limits and exactly how much AGC is being added to keep the repeater within the set output power limit range, as well as when any threshold limit is exceed which will then send the respective circuit into active MUTE / Shutdown.

Because of this, it allows the user to easily determine exactly how much additional MGC is needed to prevent the repeater from going into active AGC mode and maintain a stable output.

This page also has a unique feature called an **UL Overdrive Alarm**. This alarm was designed for scenarios where the DAS is also providing coverage to an underground parking garage and someone enters the garage with an in-car signal booster which inadvertently sends the respective UL circuit beyond its set UL limit. The repeater detects this and immediately adds AGC to the respective circuit in order to protect the macro from severe interference. If the AGC range is exceeded (10dB) the respective circuit then goes into MUTE and then attempts the auto restart sequence.

5.4 Using the GUI. (REGISTER)

The **REGISTER** page allows the user to document the contact details of who owns the repeater as well as who installed it.

A warning label is also displayed on this page.

5.5 Using the GUI. (VIEW LOGS)

The **VIEW LOGS** page allows the user back and review the type, value, band, date and time an alarm occurred. They also have the option to download the logs to excel.

Log ID	Log Value	Band	Date
Log 01#00K	Clear	2500	APR 27, 2016 @ 07:34 AM
Log 01#00K	Clear	2500	APR 27, 2016 @ 07:34 AM
Log 01#00K	Clear	2500	APR 27, 2016 @ 07:34 AM
Log 01#00K	Clear	2500	APR 27, 2016 @ 07:34 AM
Log 01#00K	Clear	2500	APR 27, 2016 @ 07:34 AM
Log 01#00K	Clear	2500	APR 27, 2016 @ 07:34 AM
Log 01#00K	Clear	2500	APR 27, 2016 @ 07:34 AM
Log 01#00K	Clear	2500	APR 27, 2016 @ 07:34 AM
Log 01#00K	Clear	2500	APR 27, 2016 @ 07:34 AM
Log 01#00K	Clear	2500	APR 27, 2016 @ 07:34 AM
Log 01#00K	Clear	2500	APR 27, 2016 @ 07:34 AM
Log 01#00K	Clear	2500	APR 27, 2016 @ 07:34 AM
Log 01#00K	Clear	2500	APR 27, 2016 @ 07:34 AM
Log 01#00K	Clear	2500	APR 27, 2016 @ 07:34 AM
Log 01#00K	Clear	2500	APR 27, 2016 @ 07:34 AM
Log 01#00K	Clear	2500	APR 27, 2016 @ 07:34 AM

6. Testing. (Flow Chart)

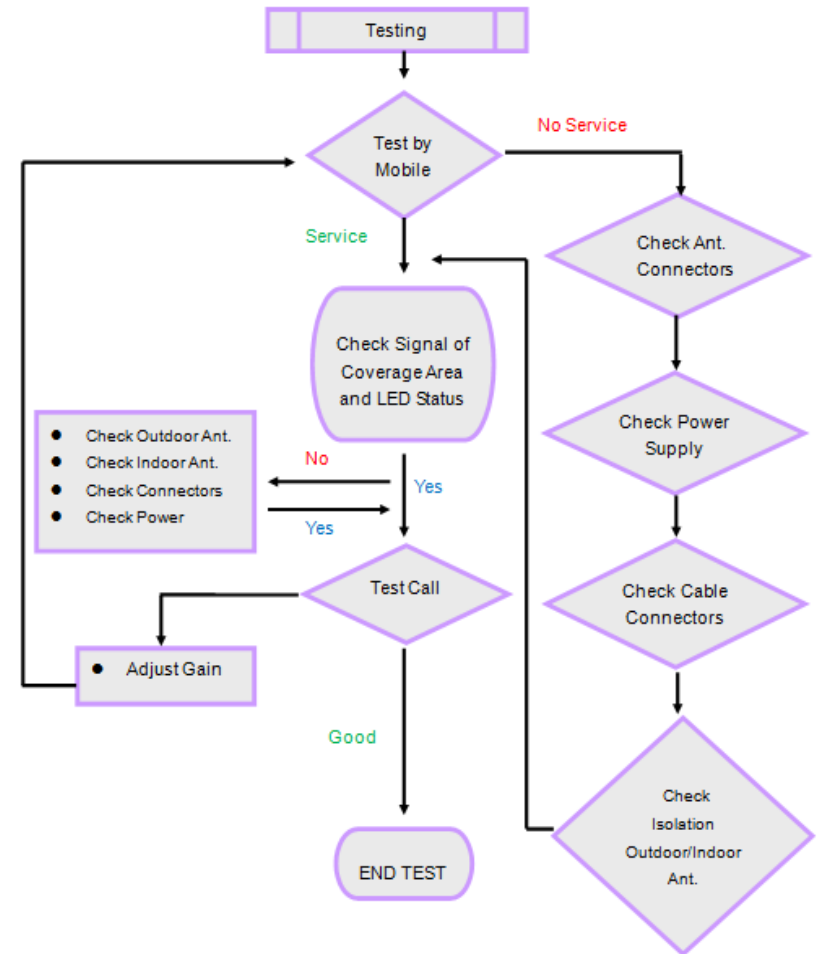

7. Troubleshooting

Q1. Why is there still no signal after installing the equipment?

Answer:

1. Check the power on repeater and power supply.
2. Check the connector of outdoor antenna is tight or not.
3. Check the connectors of RF cable are tight or not.
4. Check the outdoor signal is strong enough or not.
5. Check to make sure the antenna is installed correctly.
6. Check the connector of indoor antenna is tight or not.
7. Check the cable type is suitable or not.

Q2. Why the signal strength is too weak on the edge of area?

Answer:

1. Check the outdoor signal and antenna direction.
2. Check repeater is full gain or not.
3. Check all of the connectors are tight.
4. Change the location of outdoor/indoor antenna.
5. Check the cable type is suitable or not.
6. Deploy more indoor antennas.

Q3. Why can't I make a call after installation, even though I can detect a signal?

Answer:

1. Check LED status of repeater to make sure alarms are green.
2. Change the location of outdoor / indoor antenna.
3. Reduce the UL gain of the repeater.

Q4. The signal is not stable after turning on the repeater power.

Answer:

1. Check to see if the outdoor signal is stable or not.
2. Check the location of the donor antenna. Too close to other antennas.
3. Check the RF cable is broken or not and has no coils.
4. Confirm direction of donor antenna in relation to cell tower.

8. FCC Statement

1. FCC RF Exposure Statement

This equipment complies with FCC radiation exposure limits set forth for an uncontrolled environment. End users must follow the specific operating instruction for satisfying RF exposure compliance. This transmitter must not be co-located or operating in conjunction with any other antenna or transmitter.

2. FCC Warning

WARNING! This is NOT a CONSUMER device.

It is designed for installation by FCC LICENSEES and QUALIFIED INSTALLERS. You MUST have an FCC LICENSE or express consent of an FCC Licensee to operate this device. Unauthorized use may result in significant forfeiture penalties, including penalties in excess of \$100,000 for each continuing violation.

For North American Market.

IMPORATNT SAFETY INFORMATION

The outdoor antenna used for the purpose of communicating to the wireless infrastructure is limited to 23 dBi, or any combination of gain and loss that equates to 23 dBi at output. Each antenna must be positioned to observe minimum separation requirements from all users and bystanders.

The following guidelines should be used when considering separation distances.

INDOOR antennas must be placed such that, under normal conditions, personnel cannot come within 20 cm from any inside antenna.

OUTDOOR antenna must be positioned such that, under normal conditions, personnel cannot approach closer than 103 cm. A directional antenna having a maximum gain of 23 dBi is used, precautions should be taken to prevent personnel from routinely passing closer than specified.

9. Specifications. (Enclosure)

The JDIR-LCPA-DR37 Quad Band Digital Repeater is built in a solid enclosure resistant to dust and is lockable. To maintain safe operating temps, there is heatsink lining both the front and rear of the enclosure. Mounting brackets allow this unit to be installed on a wall.

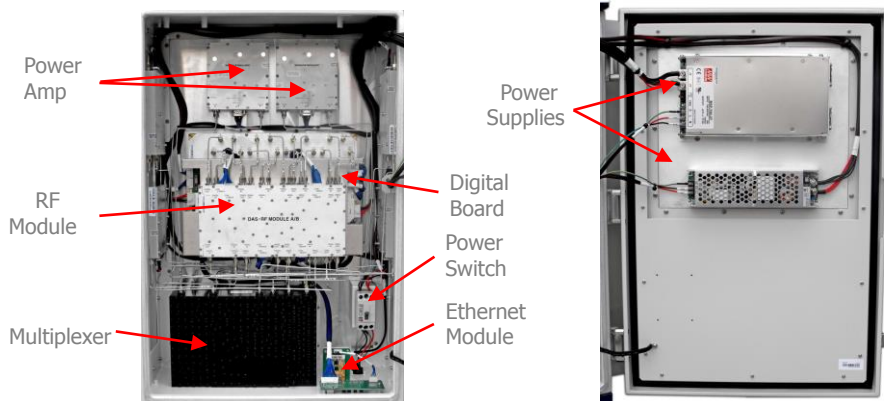

9.1 Specifications. (Data)

Frequency Specifications		Uplink		Downlink	
Frequency Range	700 MHz	18 MHz	698 ~ 716 MHz		728 ~ 746 MHz
		11 MHz	776 ~ 787 MHz		746 ~ 757 MHz
	800 MHz	25 MHz	824 ~ 849 MHz		869 ~ 894 MHz
		65 MHz	1850 ~ 1915 MHz		1930 ~ 1995 MHz
1900 MHz	45 MHz	1710 ~ 1755 MHz		2110 ~ 2155 MHz	
Preset Filter Options	1 to 2 Blocks	700 MHz 29M (A+B+LC+UC)		6M (A,B,LC) 11M (UC)	
	1 to 2	800 MHz 25M (A+B+A'+B')		11M (A)	10M (B) 1.5M (A') 2.5M (B')
	1 to 4	1900 MHz 65M (A,D,B,E,FC,G)		15M (A,B,F)	7.5M (C1, C2) 5M (D, E, F, C3, C4, C5,G)
	1 to 4	1721 MHz 45M (A,B,C,D,E,F)		10M (A,B,F) 5M (C, D, E)	
Customizable Bandwidth Options	1.2MHz, 1.23MHz, 1.25MHz, 1.4MHz, 1.5MHz, 2.5MHz, 3MHz, 3.5MHz, 3.8MHz, 5MHz, 6MHz, 7.5MHz, 10MHz, 11MHz, 14MHz, 15MHz, 18MHz, 20MHz				
Effective Bandwidth	Custom Bandwidth 900 KHz		All Bands		
Output Power	700 / 800 MHz		+20dBm Each Band Total		+34dBm Each Band Total
	1900 / 1721 MHz		+23dBm Each Band Total		+37dBm Each Band Total
Gain	Range		55~85 dB		62~92 dB
	Adjust step		1dB		
	Adjust Accuracy		+/- 1dB		
Gain Variation Over Temp.			+/- 2dB / Ambient Room Temp		
Adjacent Channel Power Compensation Level			N/A		< 15dB – Downlink
Noise Figure			<7dB @ Max Gain		
Impedance			50 Ohm		
Propagation Delay			<6usec		
CDMA Spurious Emission	>45dBc@+/- 750KHz >50dBc @+/-1.98MHz	700 / 800 MHz	1 Block @ 20dBm	1 Block @ 34dBm	
		1900 / 1721 MHz	1 Block @ 23dBm	1 Block @ 37dBm	
ACLR (LTE)	>45dBc@+/- 5MHz, >45dBc @+/-10MHz	700 / 800 MHz	1 Block @ 20dBm	1 Block @ 34dBm	
		1900 / 1721 MHz	1 Block @ 23dBm	1 Block @ 37dBm	
ACLR (WCDMA)	>45dBc@+/- 5MHz >45dBc @+/-10MHz	700 / 800 MHz	1 Block @ 20dBm	1 Block @ 34dBm	
		1900 / 1721 MHz	1 Block @ 23dBm	1 Block @ 37dBm	
Gain Flatness	700 / 800 MHz	<6dB p-p (Total Bandwidth)		<3dB p-p (Each block)	
	1900 / 1721 MHz	<8dB p-p (Total Bandwidth)		<3dB p-p (Each block)	
EVM	LTE	<8% (Including Source Signal)			
	WCDMA				
VSWR			<1.5:1		
Wave Form Quality (p) ~ CDMA			>0.98		

9.2 Specifications. (Features & Environmental)

FEATURES	
Automatic Gain Control Range (AGC)	$\geq 10\text{dB}$
Manual Gain Control Range (MGC) - Via GUI	$\geq 40\text{dB}$
Automatic Limit Control (ALC)	Will not exceed max. output power of repeater
Automatic Shutdown (MUTE)	Circuit will shut down if alarm goes RED
Uplink Sleep Mode	When no mobile is detected in range of service antenna, UL will go into sleep
ENVIRONMENTAL	
Power	AC 110V~220V
Operating Temp.	-10 ~ +55°C
RF Connector	N-type Female(RF IN_OUT), SMA Female(coupling port)
Coupling port	20dBc +/- 3dB
Environment Condition	Indoor type
Ext. Interface	RJ 45 , USB B, SMS Connection

9.3 MUTE / Shutdown Cycle Sequence.

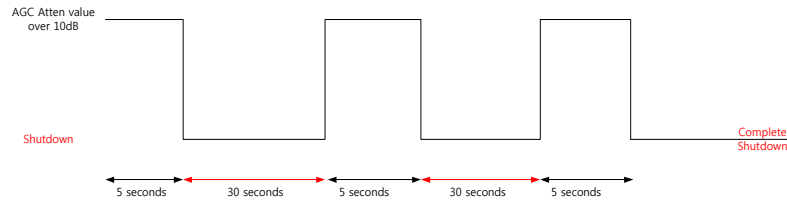

10. Abbreviations.

- ✓ AGC – Automatic Gain Control.
- ✓ ALC – Automatic Limit Control.
- ✓ DAS – Distributed Antenna System.
- ✓ DL – Downlink.
- ✓ GUI – Graphic User Interface.
- ✓ LED – Light Emitting Diode.
- ✓ MGC – Manual Gain Control.
- ✓ MUTE - Shutdown.
- ✓ RSSI – Receive Signal Strength Indicator.
- ✓ UL – Uplink.

NOTES
