

Abbreviations.....	2
Safety.....	2
1. Preface.....	3
2. Introduction / Features & Functions.....	5
3. Installation.....	7
3.1 Installation Procedure.....	8
3.1 Installation Procedure – Con’t.....	9
3.2 Antenna Installing and Cable Wiring.....	10
3.3 Manual Gain Adjustment - UL / DL.....	11
3.4 Testing.....	13
3.5 Trouble Shooting.....	14
Specifications.....	15
FCC Statement.....	16
Repeater Settings.....	17

Terminology	Meaning
AGC	Automatic Gain Control
BTS	Base Transmitting Station (Cell Tower)
CDMA	Code Division Multiple Access
dB	Decibel – (A unit of measure for signal strength)
DL	Downlink (Communication channel from cell tower to mobile device)
Donor	Outdoor Antenna (Antenna that donates an input signal)
GSM	Global System for Mobile Communications
iDEN	Integrated Digital Enhanced Network
LCD	Liquid Crystal Display
LED	Light Emitting Diode
LTE	Long Term Evolution
MS	Mobile Station
PCS	Personal Communication System
RF	Radio Frequency
UL	Uplink (Communication channel from mobile device to cell tower)

User Warnings – MUST READ!



1. This repeater must **ONLY** be used for the purpose it was intended for. Making any alternations to the design layout without first consulting with a trained technician can result in interference to the operator’s network and liability by the end user.



2. Please read this entire manual carefully before using this product!



3. Only the power supply that came with the repeater should be used at all times. It is highly recommended that the repeater is grounded and lightning protection used.



4. Do not attempt to open any part of the repeater. This will void the warranty and can cause an electric shock. Electrostatic can also cause damage to the internal components.



5. Please keep away from any heating-equipment, because the repeater will dissipate heat when working. Do not cover the repeater with anything that influences heat-dissipation.



6. Do not place or mount the repeater in a location that is exposed to the elements. This will void the warranty and can cause an electric shock.

1. Preface

Nowadays, personal mobile communication is developing at a very rapid rate and persons are having higher expectations and demands on the mobile communication network. A high-speed and high-capacity communication network has become the trend of future development. At present second-generation (2G) mobile communication systems like GSM is widely used all over the world, but mostly in developing nations, whereas third-generation (3G) and forth-generation (4G) mobile communication technology is widely used in Europe, North America and Korea.

For example, Code Division Multiple Access (CDMA) technology is used which greatly extends the signal width -- the so-called spread spectrum modulation. As an advanced wireless communication technology, it features good multi-channel access capability, anti-multipath fading capacity, anti-narrowband interference capability and security protection capabilities.

The CDMA network has, what is called a "cell breathing effect". That is, the coverage will gradually shrink as the cell load increases. The cell breathing effect makes network planning more complicated. The CDMA technology itself determines that the load of the network at the early stage of construction should be higher than that of the GSM network. Therefore, adding carriers and roaming agreements between them is a major means of expanding network capacity, and adding BTS's or Node B base stations is an auxiliary means of capacity expansion. The aim of the radio network should to provide continuous coverage, instead of hotspot coverage.

The cost of wireless repeaters are relatively low and the construction is simple. They have the functions of a mini BTS or Node B. On the network, repeaters can help a BTS or Node B to achieve the optimal network quality at a minimum cost.

A cellular tower typically supports a large capacity of users but is affected by a relatively small coverage footprint. Therefore, the number of users who can access it is limited and a large amount of channel resources are wasted. The best way of solving this problem is to use repeaters to extend the BTS coverage to fully utilize the telecommunication resources. For example, in cellular network construction in Asia, repeaters are no longer considered as peripheral devices to cover blind areas in the network but as part of the core network itself.

The complete coverage is not only a prerequisite for a high quality mobile cellular network, but also a factor that attracts users. From this point of view, a network operator should first consider providing a radio network with a complete coverage. The seamless coverage in urban areas, heavy traffic areas, office buildings, super markets, and top grade hotels is the first step to consummate the network.

In such a background, JDTECK has successfully developed advanced repeaters that are applicable to any mobile network and indoor distributed antenna system. (DAS) Repeaters are available to support any technology or frequency used today.

Because a large amount of BTS or Node B devices are deployed in densely populated urban areas, there is usually no large blind area. Repeaters are simply used to cover small blind areas and provide signal coverage inside buildings or sub-ground locations. Typically, radio frequency (RF) repeaters are used when optical fibers are not available in buildings or when using a fiber solution is not cost effective.

Since the number of repeaters on a cellular network usually increases with the number of buildings to be covered in a specific sector, multiple repeaters may end up feeding from one BTS or Node B. In view of this, only low powered repeaters (below 1 W) should be deployed in densely populated areas.

Repeaters adopt an integrated module concept. It is compact in structure and combines the RF module and the monitoring mode in one unit. Owing to its high selectivity, stability and reliability, repeaters are widely applied to indoor signal distribution in small areas such as office buildings, meeting rooms, hotels, tea shops, night clubs, and cafes where signals are shielded. They are also used to cover shadow areas outdoors. Such repeaters are very suitable to signal optimization in densely populated urban areas.

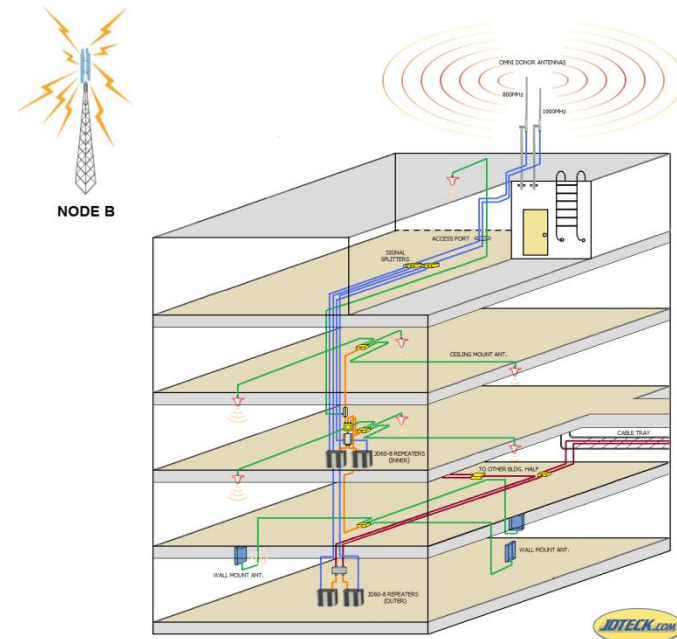

Figure 1 shows the applications of the repeaters.

2. Introduction

This full duplex mobile communications repeater from JDTECK is the perfect solution for providing a wireless improvement in the cellular reception of a large home, office building, restaurant, VIP Room, apartment, or night club in the quickest time possible.

It is designed to improve the call quality of an area by receiving, amplifying, filtering and re-transmitting the signals from the base station into a specified area via a distributed antenna system (DAS) or distributed antenna grid.

To maintain safe and specific output signal levels, this repeater has built-in signal oscillation detection circuits with color changing LEDs to indicate its environmental status. The Alarm LEDs located on the front of the unit (Downlink Alarm & Uplink Alarm) will change color from green to amber or red, (depending on the intensity) if the system detects signal oscillation in either band, or if the input signal is beyond a safe limit so as to avoid interference to the cellular network, the repeater will indicate this.

This repeater also has an automatic gain control (AGC) feature which will reduce the output power of the repeater if oscillation is detected. This range can vary from 15-20dB depending on the model of your repeater. If the reduction in gain needed to take the unit out of alarm exceeds the range of the AGC, then the end user can make use of yet another feature of this repeater called manual gain control (MGC). This allows the end user to further reduce the output gain of the repeater by using the push buttons on the front of the unit to navigate through the liquid crystal display (LCD) and manually attenuate (reduce) the repeater's output gain of either the uplink or downlink individually.

JDTECK's repeaters also feature a Network Safe / MUTE feature that automatically shuts-down the transmission side of the repeater to protect the cellular network if no adjustments are made to eliminate alarm readings on the repeater's LEDs. You will want to make sure the LEDs remain green at all times for optimum system performance.

The main cause of signal oscillation is when any of the indoor antennas are too close in proximity to the outdoor antenna on the roof.

Alarm LED status chart and recommended action:

- Green** - System functioning well.
- Amber** - Mild detection of oscillation.
- Red** - Strong signal oscillation.
- Off** - Repeater is not transmitting (MUTE Activated)

Features & Functions

- ✓ Sleek attractive housing.
- ✓ LED indicators to monitor environmental status.
- ✓ Supports all technologies including GPRS, GSM, CDMA, UMTS & LTE
- ✓ Low power consumption.
- ✓ ALC function. (Auto Limit Control – will not exceed max rated power)
- ✓ AGC function. (Automatic Gain Control)
- ✓ MGC function. (Manual Gain Control)
- ✓ MUTE function. (Shuts down if no change in environmental conditions)
- ✓ LCD Interface. (User Friendly Digital Interface)
- ✓ Heat Sink cooling fins to dissipate heat quickly and efficiently

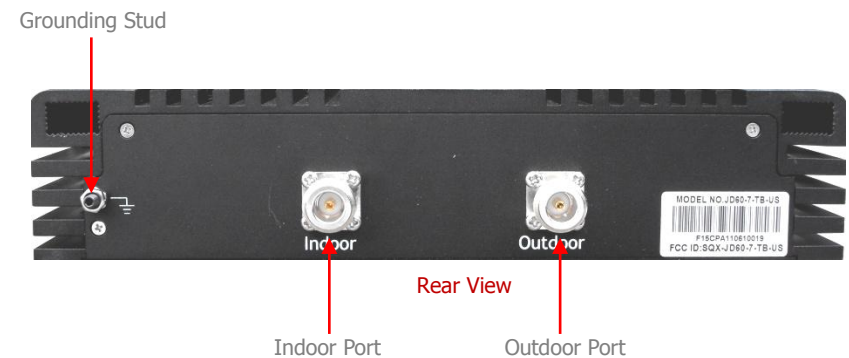
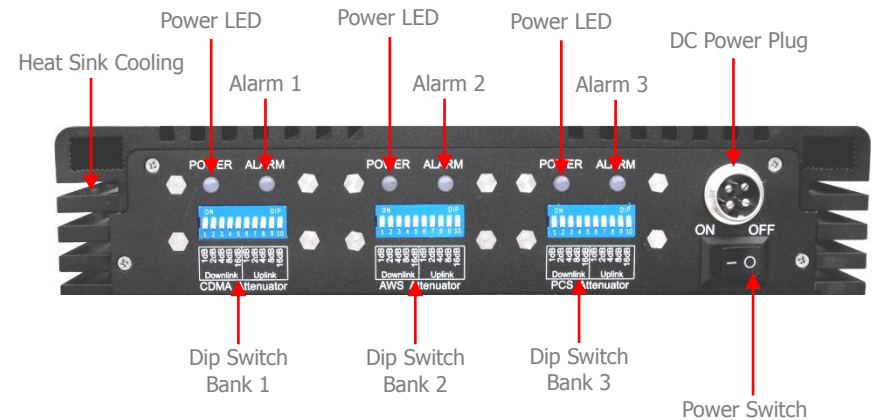

3. Installation

1. The repeater's main function is to improve weak RF signals to an area.
2. Selecting the appropriate accessories that are compatible with the frequency of the repeater is very important for optimal system performance. An 850Mhz Repeater needs to be used with accessories that supports the 850Mhz band. In the same way, choosing accessories in the 1900Mhz Band needs to go with a 1900Mhz Repeater etc. For dual band or multi-band repeaters, please ensure the peripheral components used supports all the frequencies needed.
3. The signal strength from the outdoor antenna directly affects the efficiency of the indoor coverage. Therefore it is very important to choose the location of the outdoor antenna carefully. With this in mind, it is not recommended that the donor antenna be installed in an attic or at the side of a building.
4. The repeater is a two-way (full duplex) signal amplifier. Therefore there needs to be proper isolation between the outdoor antenna and indoor antenna in order to avoid signal oscillation on the repeater. (Interference) There needs to be more than 15dB of isolation above the repeater gain. For example, if the repeater gain is 60dB, then you need 75dB of isolation between outdoor antenna and indoor antenna.
5. The repeater gain is adjustable for both the uplink / downlink individually. Depending on the environment, the end-user may need to adjust the repeater gain to achieve optimum performance and desired coverage.
6. The repeater is designed to amplify the input signal, filter it and retransmit it to the desired area via service antennas. In order to reach the best performance, the outdoor signal should be greater than -80dBm, and not over +10dBm. If the outdoor signal is very weak, then a pre-amplifier may be used.
7. Calculating the Link budget before setting the repeater gain.

Link budget calculation:

Outdoor signal strength – Loss of accessories (cable, connectors, splitters, Directional Couplers) + Antenna gain (outdoor antenna, indoor antenna) + Repeater gain = Indoor signal strength.

8. For all cellular applications, you need to use 50 Ohm rated coax. Besides affecting voice quality, using any other impedance of coax will put an extra load on your repeater and shorten its life span.

3.1 Installation Procedure

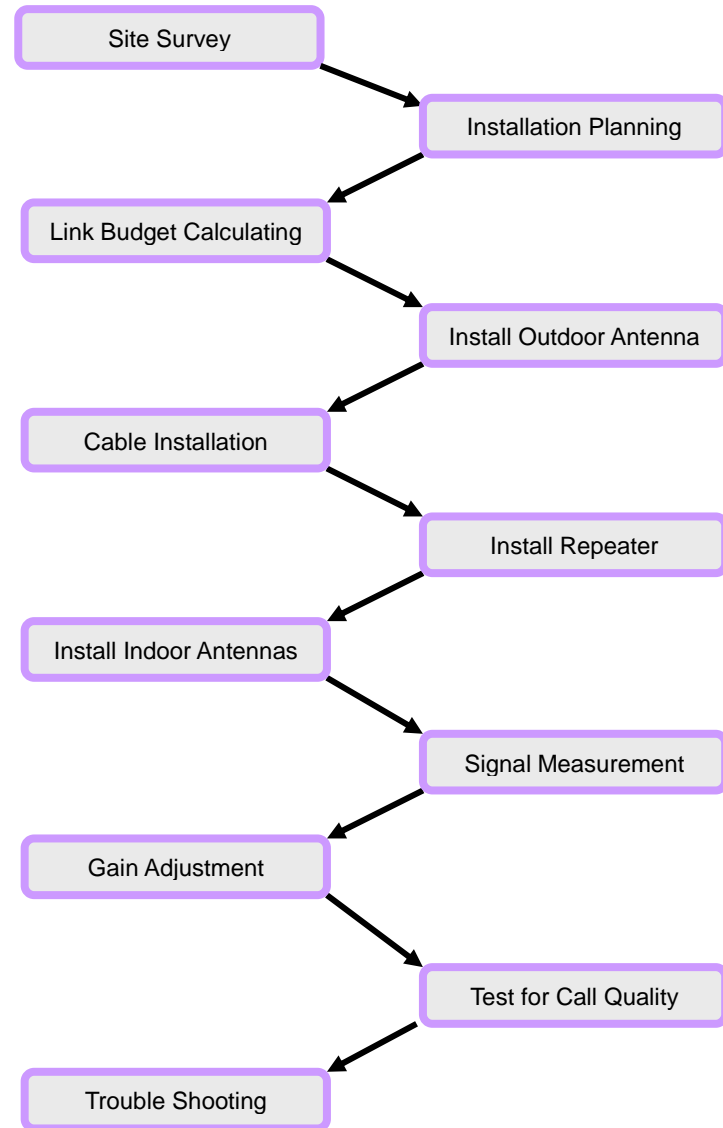

3.1 Installation Procedure – Cont.

- Check the contents supplied.
- Identify a suitable location where you would like to mount the donor antenna on your roof or at an elevated location, free of any other antennas or immediate obstructions. Confirm this location has the best input signal from the cell tower or towers you would like to support.
- Ensure the location is properly isolated from the indoor antenna and at the same time, ensure the cable length supplied is sufficient to complete your installation.
- Install the donor antenna and route the coax to the proposed location for the indoor base unit. **DO NOT COIL UP** any excess coax you may have, including any service loops.
- Connect the indoor service antennas, coax and power supply. Power up the unit and monitor the LED status for errors.
- If the donor antenna used is not an omni-directional antenna or the nearest cell tower location is not known at the time of system commissioning, then you may need to rotate the donor antenna until the best signal strength or call quality is achieved on your mobile device, while making sure the LEDs stay green on the repeater.

We suggest getting someone to help rotate the donor antenna while you monitor both your mobile device (Phone or PC Card) and the LEDs on the repeater at the same time.

- If signal oscillation is between 1~4dB then the Alarm LED for the relevant band will turn amber. Please adjust the DL repeater gain till the LEDs turn green. (See attenuation adjustment)
- If the signal oscillation is between 10-15dB then the Alarm LED for the relevant band will turn red, and the repeater will then shut down. This is as a result of not having enough isolation between the donor and service antennas. In this case attenuate the DL gain on the repeater and then match the UL gain to the same gain value. (See attenuation settings for adjustments)

3.2 Antenna Installation and Coax Cable Wiring

We do not recommend installing the donor antenna of your repeater system in the attic or at the side of a single story building. Doing so will reduce the quality of the input signal from the cell tower. Also you increase the risk of signal oscillation taking place, thus having to attenuate the output power of your repeater.



- Do not install the donor antenna near high voltage power lines.
- Please take the necessary safety measures when working on heights.
- Do not mount near or in the path of other antennas or satellite dishes.



It is recommended that you mount your donor antenna in a spot that is free of any immediate obstructions. Making use of a pole or mounting bracket is recommended for optimum antenna performance.



3.3 Manual Gain Adjustment ~ UL / DL

In order to meet and maintain safe environmental conditions for seamless network integration, this repeater is equipped with a dip switch assembly that allows you to manually control the Uplink / Downlink gain individually. The UL / DL attenuator control range is from 0dB to -31dB by 1dB increments in each band. There is a dip switch bank available for each frequency.

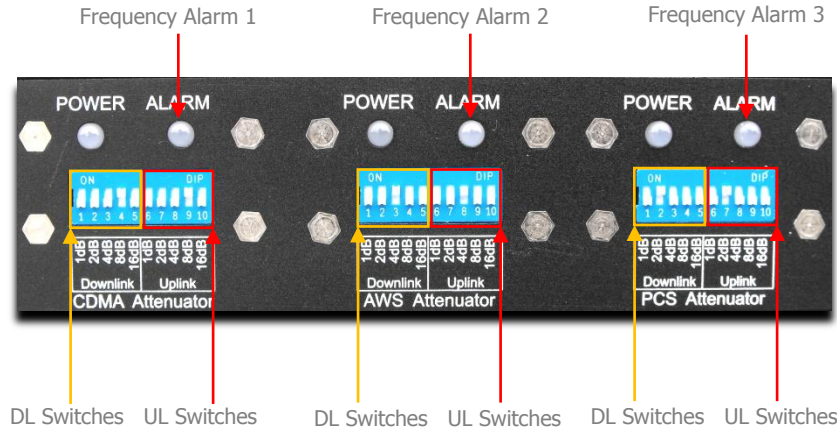

The DIP Switch control method is described as below.
Switches 1-5 represents DL and 6-10 represents UL.

The default of UL/DL gain attenuator is at 0dB. (Full Power)

Example of the DL & UL Attenuated by 4dB

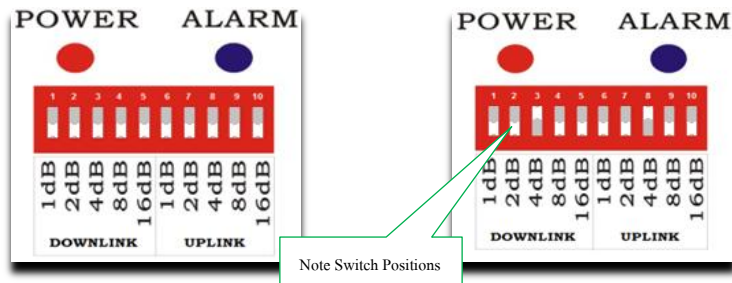

Avoid putting more than a 5dB difference between the Uplink and Downlink.

3.3 Manual Gain Adjustment ~ UL / DL – Con't.

When do you adjust the Repeater Gain?

This repeater is equipped with an alarm feature that monitors the input gain. If the input gain is too high, the DL Alarm LED will change color from green to either, amber or red indicating the intensity or the error. High input gain can occur if the donor antenna is in a location where the receive signal strength (RSSI) from the cell tower is extremely good (-50dB or better) or if signal oscillation is taking place. Signal Oscillation is when the amplified signal from the indoor service antenna is being received back into the donor antenna outside.

To determine what is the cause of your Alarm LED changing color you can disconnect the indoor antenna / service line from the "INDOOR" port of the repeater. If the LED does not change to green, then your input signal from the cell tower is very strong and it is highly recommended you attenuate the DL gain by 1dB increments till the LEDs turns green again. Then you must match the same attenuation value to the UL, after which you can connect the indoor antenna / service line again.

If after reconnecting the indoor antenna or service line, the LED changes back to amber or red then signal oscillation is taking place. This is the result of your **indoor** and **outdoor** antennas being too close to each other and should therefore have more separation.

When complete, try making some test calls throughout the desired area of coverage while monitoring the LEDs to see if it changes color. If you are showing strong signal strength but your calls are not going through, it could be that you need to attenuate your uplink gain a bit more. Keep in mind however that you do not want to have more than a 5dB difference between the uplink and downlink values for optimum system performance.

We encourage you to call us when commissioning your repeater system to make sure you have seamless integration to the cellular network. We are always happy to help. **1-866-4-JDTECK (53-8325)**.

3.4 Testing

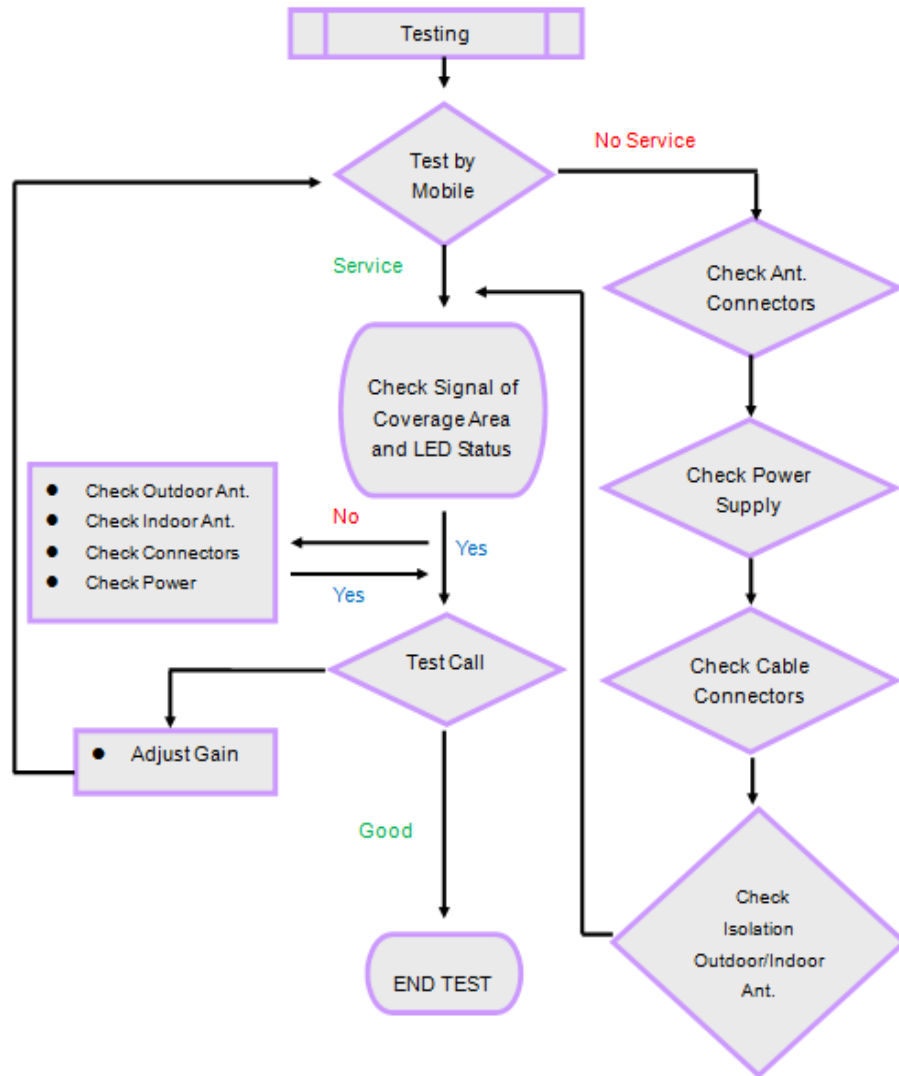

3.5 Troubleshooting

Q1. Why is there still no signal after installing the equipment?

Answer:

1. Check the power on repeater and power supply.
2. Check the connector of outdoor antenna is tight or not.
3. Check the connectors of RF cable are tight or not.
4. Check the outdoor signal is strong enough or not.
5. Check to make sure the antenna is installed correctly.
6. Check the connector of indoor antenna is tight or not.
7. Check the cable type is suitable or not.

Q2. Why the signal strength is too weak on the edge of area?

Answer:

1. Check the outdoor signal and antenna direction.
2. Check repeater is full gain or not.
3. Check all of the connectors are tight.
4. Change the location of outdoor/indoor antenna.
5. Check the cable type is suitable or not.
6. Deploy more indoor antennas.

Q3. Why can't I make a call after installation, even though I can detect a signal?

Answer:

1. Check LED status of repeater to make sure alarms are green.
2. Change the location of outdoor / indoor antenna.
3. Reduce the UL gain of the repeater.

Q4. The signal is not stable after turning on the repeater power.

Answer:

1. Check to see if the outdoor signal is stable or not.
2. Check the location of the donor antenna. Too close to other antennas.
3. Check the RF cable is broken or not and has no coils.
4. Confirm direction of donor antenna in relation to cell tower.

Q5. Why is the LED on the front of the repeater not lit?

Answer:

1. Check the power source is normal or not.
2. MUTE feature is active. Attenuate gain of repeater and cycle power.

Mechanical Specifications

Input / Output Port	N-Female
Impedance	50 Ω
Dimensions (W x D x H)	250 x 210 x 53mm
Weight	≤4.4Kg (9.5Lbs)
Operating Temperature	-10°C ~ 50°C
Environment Conditions	IP40
Switching Adapter	Input AC 90~265V, Output DC 12V / 5A

Frequency Specifications

Model	JD60-6-TB	JD60-7-TB
FCC ID	SQXJD60-7-TB-US	
Filter Bandwidth	GSM & CDMA 25MHz PCS 60MHz DCS 75MHz WCDMA 60MHz	GSM & CDMA 25MHz PCS 60MHz DCS 75MHz WCDMA 60MHz
Max total output power	Downlink ≥13dBm Uplink ≥10dBm	Downlink ≥15dBm Uplink ≥10dBm
Max. Gain	≥65dB	≥70dB
Gain Flatness	CDMA & GSM: ≤8dB, PCS & DCS: ≤10dB WCDMA & AWS ≤6dB	CDMA & GSM: ≤8dB, PCS & DCS: ≤10dB WCDMA & AWS ≤6dB
AGC Range	≥20dB	≥20dB
Maximum Input Power	0dBm	0dBm
Gain Control Range(MGC)	≥31dB in 1 dB step	≥31dB in 1 dB step
V.S.W.R	≤2	≤2
Inter-modulation Products	9KHz~1GHz≤-36dBm 1GHz~12.75GHz≤-30dBm	9KHz~1GHz≤-36dBm 1GHz~12.75GHz≤-30dBm
Spurious Emission	9KHz~1GHz≤-36dBm 1GHz~12.75GHz≤-30dBm	9KHz~1GHz≤-36dBm 1GHz~12.75GHz≤-30dBm
Spurious Emission Mask	Complies with 3GPP TS 25.106	Complies with 3GPP TS 25.106
Modulation Accuracy	Complies with 3GPP TS 25.106	Complies with 3GPP TS 25.106
Peak Code Domain Error	Complies with 3GPP TS 25.106	Complies with 3GPP TS 25.106
Frequency Stability	≤0.01ppm	≤0.01ppm
ACPR	≥30dB @±5MHz&±10MHz	≥30dB @±5MHz&±10MHz
Noise Figure (@ max gain)	≤6dB	≤6dB
Group Delay	≤0.5 micro Sec	≤0.5 micro Sec

Model Specifications

Classification	Bandwidth Range (MHz)
A. Frequency Range CDMA / TDMA / GSM 850 / HSPA PCS / CDMA / GSM / GPRS / AWS 800 / 1900 / 1721Mhz	DL - 869-894 / 1930-1990 / 2110-2155 UL - 824-849 / 1850-1910 / 1710-1755
B. Frequency Range (GSM / DCS / GSM / WCDMA / UMTS) 900 / 1800 / 2100Mhz	DL - 935-960 / 1805-1880 / 2110-2170 UL - 890-915 / 1710-1785 / 1920-1980

FCC Statement

PLEASE NOTE: It is normal for your repeater to be quite warm while in use.

This device complies with part 15 of the FCC Rules. Operations subject to the following two conditions: (1) This device may not cause harmful interference, and (2) this device must accept any interference received, including interference that may cause undesired operation. Changes or modifications not expressly approved by the party responsible for compliance could void the user's authority to operate the equipment.

FCC Radiation Exposure Statement:

This equipment complies with FCC radiation exposure limits set forth for an uncontrolled environment . This equipment should be installed and operated with minimum distance 20cm between the radiator& your body. This transmitter must not be co-located or operating in conjunction with any other antenna or transmitter.

Record your repeater settings here.

Downlink			Uplink		
Dip Switch	Value	ON	Dip Switch	Value	ON
1	1dB	<input type="checkbox"/>	1	1dB	<input type="checkbox"/>
2	2dB	<input type="checkbox"/>	2	2dB	<input type="checkbox"/>
3	4dB	<input type="checkbox"/>	3	4dB	<input type="checkbox"/>
4	8dB	<input type="checkbox"/>	4	8dB	<input type="checkbox"/>
5	16dB	<input type="checkbox"/>	5	16dB	<input type="checkbox"/>
Total dB Attenuated		Total dB Attenuated	

Adjusted By: _____	Date: _____/_____/_____
--------------------	-------------------------

Downlink			Uplink		
Dip Switch	Value	ON	Dip Switch	Value	ON
1	1dB	<input type="checkbox"/>	1	1dB	<input type="checkbox"/>
2	2dB	<input type="checkbox"/>	2	2dB	<input type="checkbox"/>
3	4dB	<input type="checkbox"/>	3	4dB	<input type="checkbox"/>
4	8dB	<input type="checkbox"/>	4	8dB	<input type="checkbox"/>
5	16dB	<input type="checkbox"/>	5	16dB	<input type="checkbox"/>
Total dB Attenuated		Total dB Attenuated	

Adjusted By: _____	Date: _____/_____/_____
--------------------	-------------------------

NOTES
